



Health

# Certificate of Accreditation

## Sewage Management Facility

### Septic Tanks & Collection Wells

*This Certificate of Accreditation is issued by the Secretary of the NSW Ministry of Health pursuant to Clause 41(1) of the Local Government (General) Regulation 2005.*

*Manufacturer: Suncoast Waste Water Management*

*Of: 59 Industrial Ave, Kunda Park, QLD, 4556*

*The Ozzi Kleen Septic Tanks, Pump Wells and Collection Wells as described in the following Schedule have been accredited as sewage management facilities for use in single domestic premises in NSW.*

*Director, Environmental Health  
for Secretary (delegation PH335)*

*Issued: 23 October 2018  
Certificate No: STCW041  
Expires: 31 December 2023*



Health

## *Accreditation Schedule*

*The Certificate of Accreditation applies to the following  
Septic Tanks and Collection Wells*

Model	Description	Size
Septic Tank ST 10 ST 10A	Vertical axis type cylindrical roto moulded polyethylene tank. Certification applies only to the construction of the septic tank, baffle and access covers. It does not include the internal fittings. Burial depth of the tank lid is restricted to 0 mm	4506 L 4506 L
Collection Well PT 4000 Single Turret PT4000 Twin Turret PT1000 Flat Base PT1000 Hopper Bottom PT5300 Flat Base PT5300 Hopper Bottom	Vertical axis type cylindrical roto moulded polyethylene tank. Certification applies only to the construction of the collection well and access covers. It does not include the internal fittings. Burial depth of the tank lid is restricted to 0 mm	4150 L 4150 L 1208 L 1225 L 5350 L 5250 L
Pump Well PT350 PT500 PT850 PT1500 Flat Base PT1500 Hopper Bottom	Vertical axis type cylindrical roto moulded polyethylene tank. Certification applies only to the construction of the pump well and access cover. It does not include the internal fittings. Burial depth of the tank lid is restricted to 0 mm	350 L 663L 850 L 1735L 1640L

**APPROVED**  
**23 OCT 2018**  
 NSW MINISTRY OF HEALTH

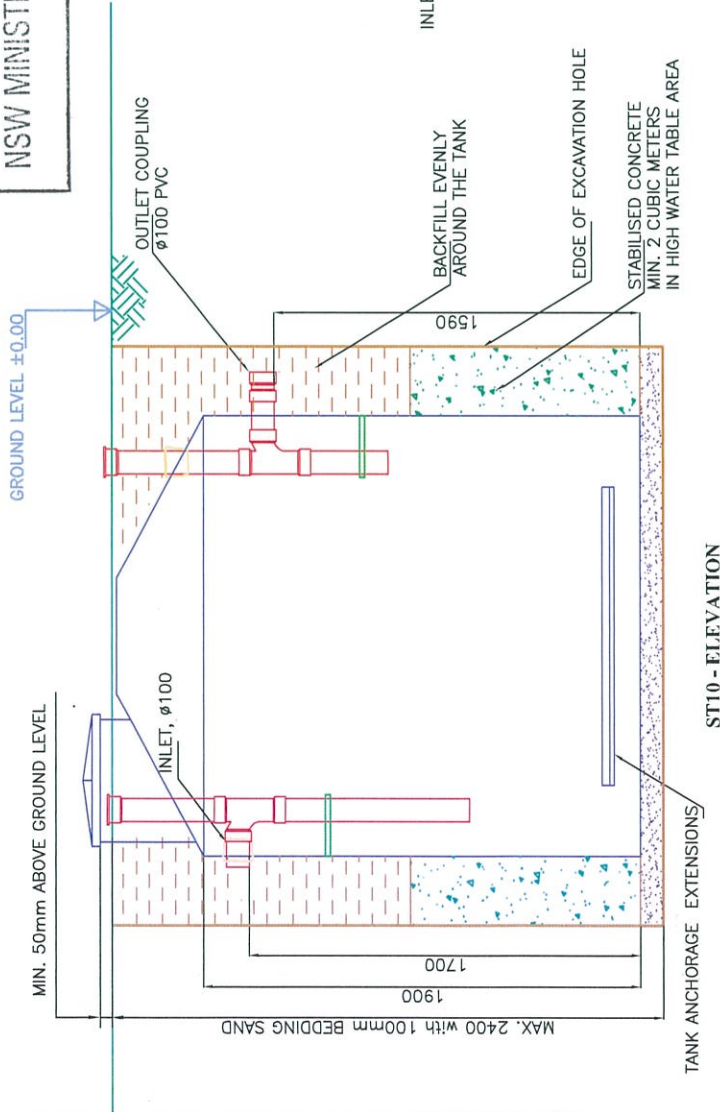

**ST10 - ELEVATION**

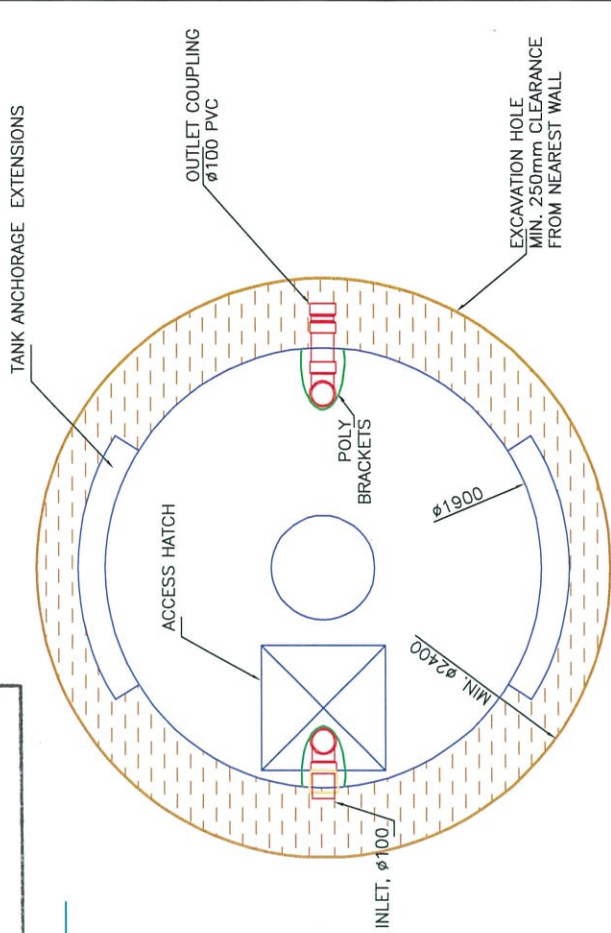

**ST10 - PLAN**

- NOTES:**
- Ozzi Kleen POLYETHYLENE TANK IS CERTIFIED TO AS/NZS 1546.1.
  - PLEASE SEE INSTALLATION GUIDELINES FOR MINIMUM REQUIREMENTS.
  - PLEASE CONFIRM INVERT LEVELS WHEN ORDERING.

		CLIENT: 59 INDUSTRIAL AVE KUNDA PARK QLD 4556 PH: +61 7 5459 4900 FAX: +61 7 5459 4877 www.ozzikleen.com		GENERAL PROJECT: 4-500L SEPTIC TANK - ST10		DESIGN: AP
		TITLE: GENERAL LAYOUT DWG NO.: GD-ST10-HTO		DATE: 02/02/16 SCALE: NTS		
Suncoast Waste Water Management		DATE: 02/02/16 DESCRIPTION: GENERAL REVISION		REV. 1 YH	BY	

APPROVED

23 OCT 2018

NSW MINISTRY OF HEALTH

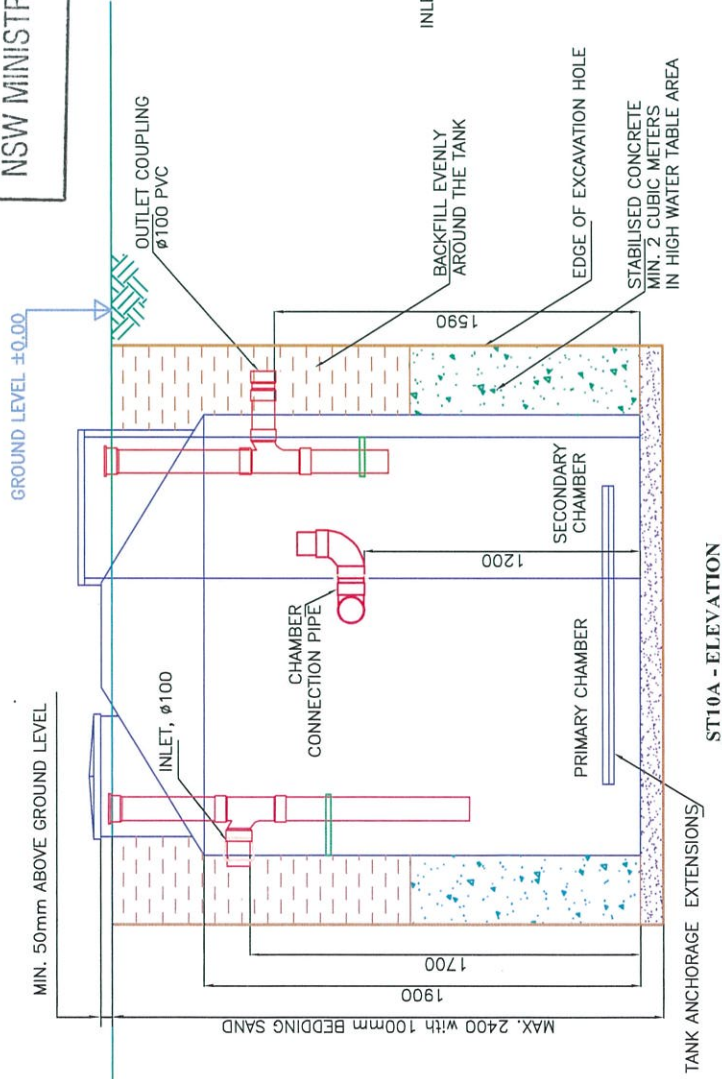

ST10A - ELEVATION

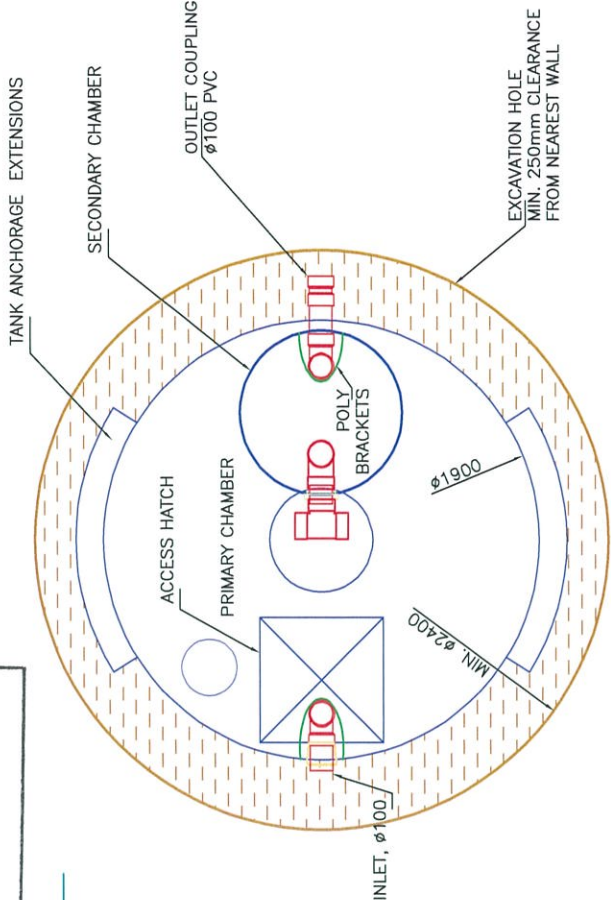

ST10A - PLAN

NOTES:

1. Ozzi Kleen POLYETHYLENE TANK IS CERTIFIED TO AS/NZS 1546.1.
2. PLEASE SEE INSTALLATION GUIDELINES FOR MINIMUM REQUIREMENTS.
3. PLEASE CONFIRM INVERT LEVELS WHEN ORDERING.

		Suncoast Waste Water Management	
56 INDUSTRIAL AVE KUNDA PARK QLD 4556 PH +61 7 5459 4900 FAX +61 7 5456 4677 www.ozzikleen.com	CLIENT GENERAL	PROJECT 4,500L SEPTIC TANK - ST10A	DESIGN AP
DATE 02/02/16	GENERAL REVISION 1	TITLE GENERAL LAYOUT	DRAWN YH
DESCRIPTION	REV.	DWG NO. GD-ST10A-H10	CHKD AP
BY	NTS	SCALE	DATE 02/02/16

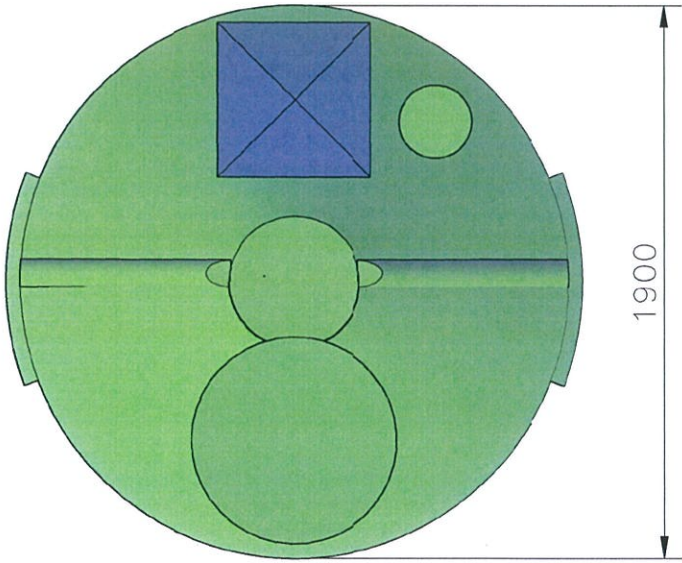

**Australian Standard**  
AS/NZS 1546.1  
Lic SMKB20032  
SAI Global

**OZZI KLEEN  
COLLECTION WELL  
MODEL PT4000  
SINGLE TURRET  
4,150 LITRE CAPACITY**

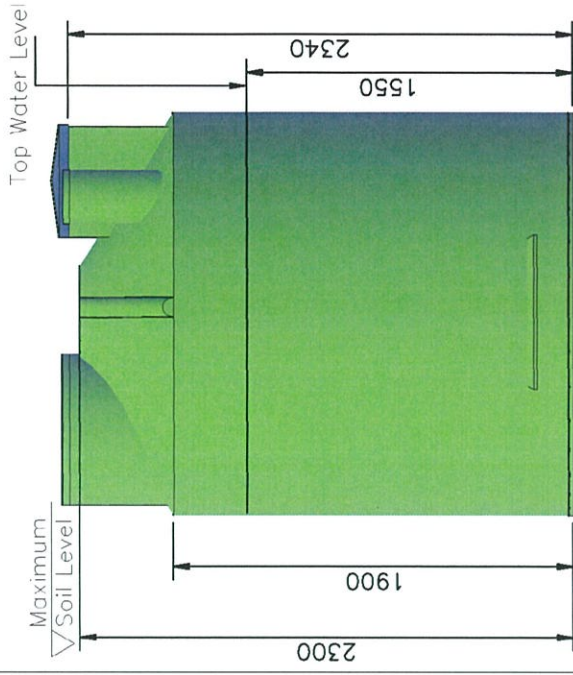
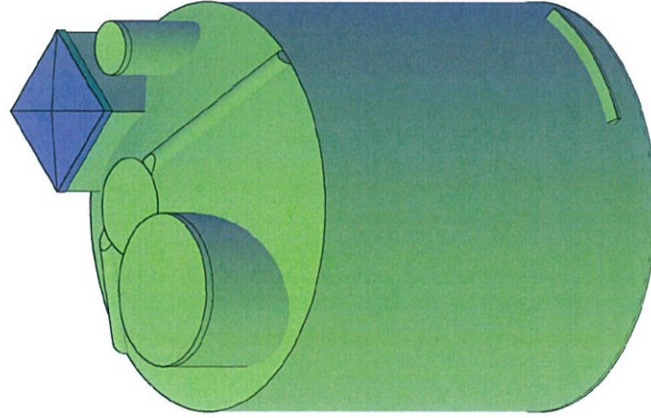

**APPROVED**  
**23 OCT 2018**  
**NSW MINISTRY OF HEALTH**

DATE	23/11/15	ISSUED FOR APPROVAL	1	YH	REV.	BY	DESCRIPTION	SCALE	DATE	CHKD	DRWN	DESIGN	MC
<p><b>OZZI KLEEN</b> Water &amp; Waste Water</p> <p>Suncoast Waste Water Management</p>								<p>CLIENT: GENERAL</p> <p>PROJECT: COLLECTION WELL PT4000 SINGLE TURRET</p> <p>TITLE: GENERAL DRAWING</p> <p>DWG NO. GD-PT4000GTS-H10</p>	<p>59 INDUSTRIAL AVE KUNDA PARK QLD 4350 PH +61 7 5459 4900 FAX +61 7 5458 4677 www.ozzikleen.com</p>	<p>GENERAL</p> <p>COLLECTION WELL PT4000 SINGLE TURRET</p> <p>GENERAL DRAWING</p> <p>GD-PT4000GTS-H10</p>	<p>NSW MINISTRY OF HEALTH</p>		

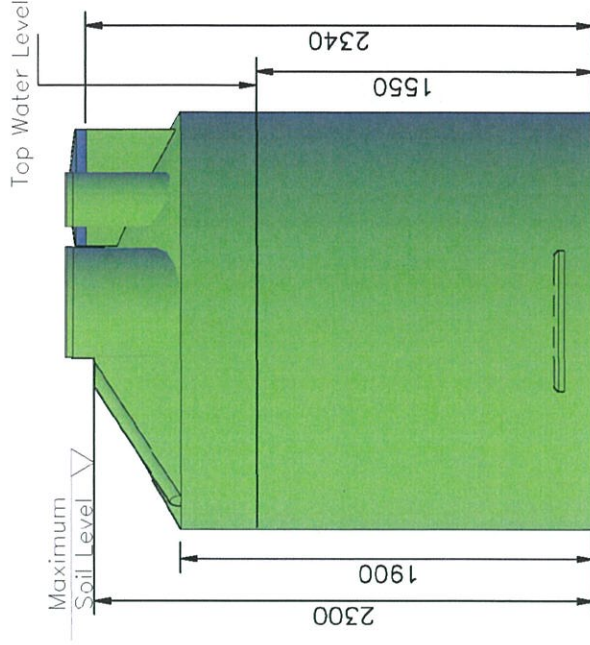
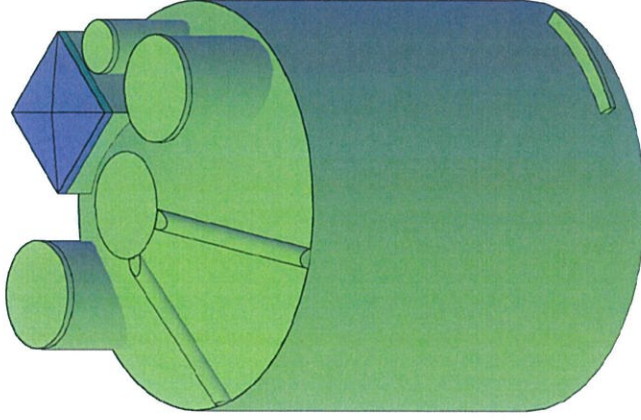
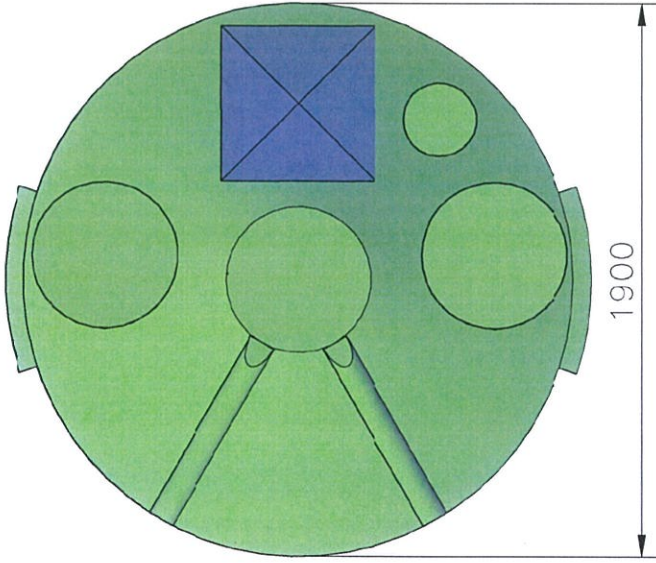

**OZZI KLEEN**  
**COLLECTION WELL**  
**MODEL PT4000**  
**TWIN TURRET**  
**4,150 LITRE CAPACITY**

**Certified Product**<sup>TM</sup>  
**Australian Standard**  
 AS/NZS 1546.1  
 Lic SMK20032  
 SAI Global

**APPROVED**  
**23 OCT 2018**  
**NSW MINISTRY OF HEALTH**

59 INDUSTRIAL AVE KUNDA PARK QLD 4556 TEL +61 7 5459 4800 FAX +61 7 5459 6777 www.ozzikleen.com	CLIENT	GENERAL	DESIGN	MC
	PROJECT	COLLECTION WELL PT4000 TWIN TURRET	DRAWN	YH
	TITLE	GENERAL DRAWING	CHKD	AP
	DWG No.	GD-PT4000RP-H10	DATE	23/11/15
			SCALE	NTS
Suncoast Waste Water Management				
23/11/15	ISSUED FOR APPROVAL	1	YH	
DATE	DESCRIPTION	REV.	BY	



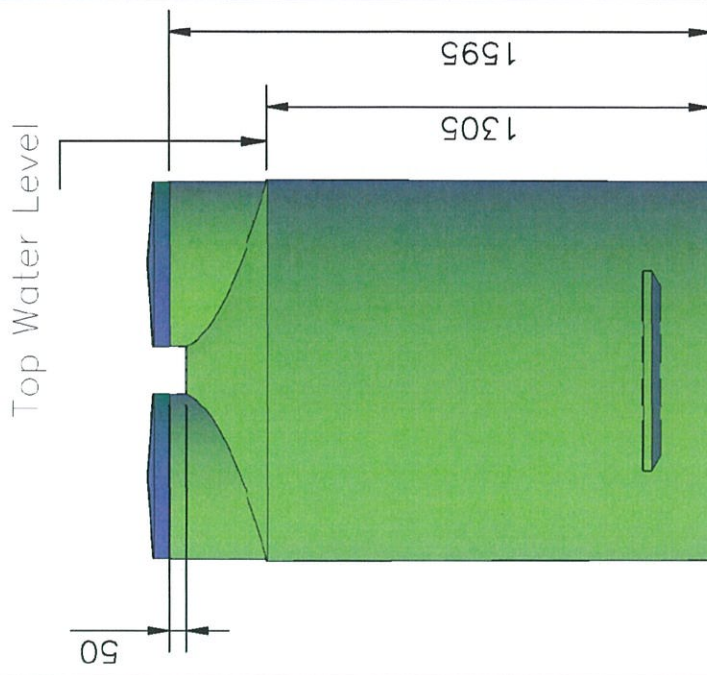
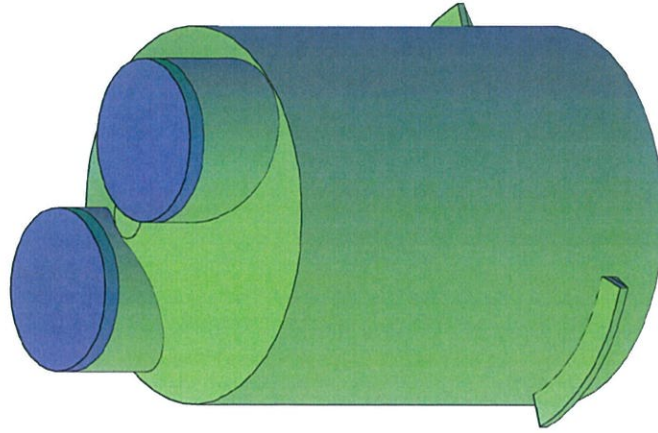
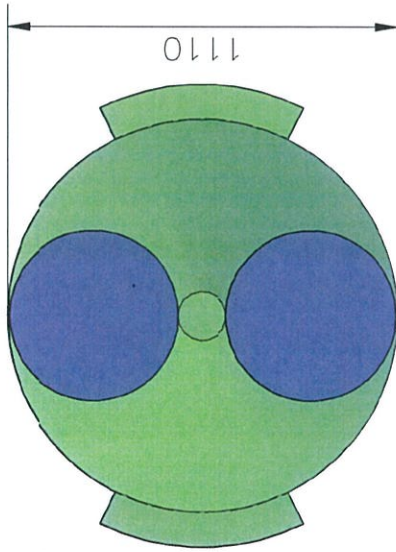

**OZZI KLEEN**  
**COLLECTION WELL**  
**MODEL PT1000**  
**FLAT BASE**  
**1,208 LITRE CAPACITY**

**Certified Product**<sup>TM</sup>  
**Australian Standard**  
 AS/NZS 1546.1  
 Lic SMK20032  
 SAI Global

**APPROVED**  
**23 OCT 2018**  
**NSW MINISTRY OF HEALTH**

59 INDUSTRIAL AVE KUNDA PARK QLD 4556 PH +61 7 5459 4800 FAX +61 7 5458 4877 www.ozzikleen.com	CLIENT GENERAL	DESIGN MC	23/11/15
	PROJECT COLLECTION WELL PT1000 FLAT BASE	DRAWN YH	
	TITLE GENERAL DRAWING	CHKD AP	
	DWG NO. GD-PT1000FB-H10	DATE 23/11/15	
		SCALE NTS	
		Suncoast Waste Water Management	
23/11/15	ISSUED FOR APPROVAL	1	YH
DATE	DESCRIPTION	REV.	BY

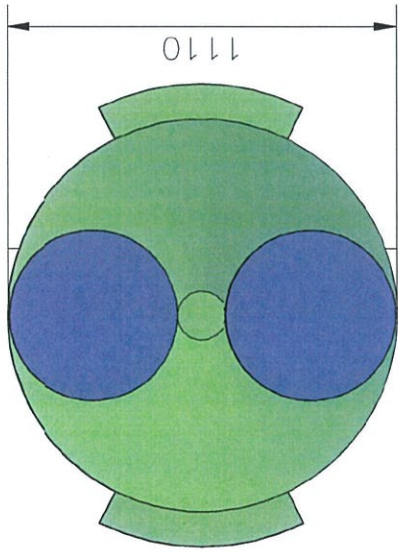

**Australian Standard**  
 AS/NZS 1546.1  
 Lic SMK20032  
 SAI Global

**OZZI KLEEN  
 COLLECTION WELL  
 MODEL PT1000  
 HOPPER BOTTOM  
 1,225 LITRE CAPACITY**

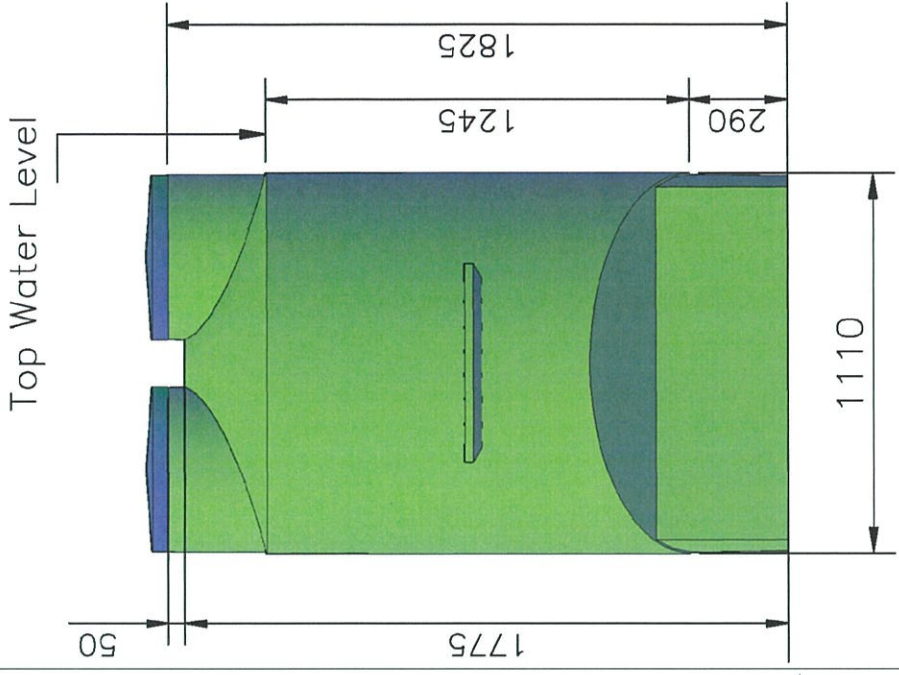
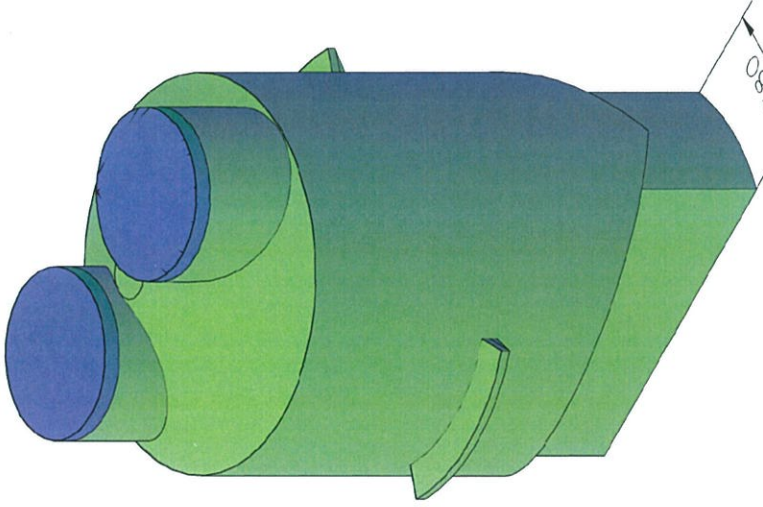

23/11/15	ISSUED FOR APPROVAL	1	YH	BY
DATE	DESCRIPTION	REV.		
Suncoast Waste Water Management				
		CLIENT: GENERAL PROJECT: COLLECTION WELL PT1000 HOPPER BOTTOM TITLE: GENERAL DRAWING DWG NO.: GD-PT1000HB-H10		
58 INDUSTRIAL AVE KUNDA PARK QLD 4556 PH +61 7 5459 4900 FAX +61 7 5459 4677 www.ozzikleen.com		DESIGN: MC DRAWN: YH CHKD: AP DATE: 23/11/15 SCALE: NTS		



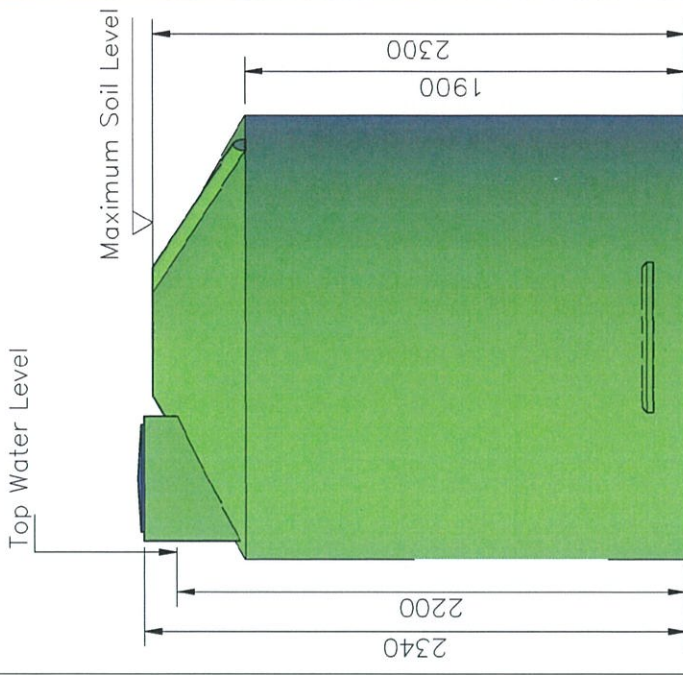
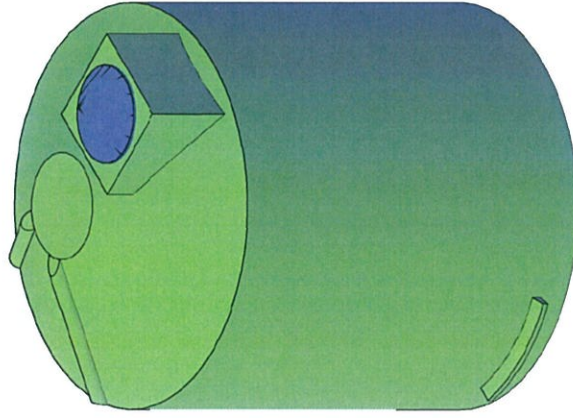
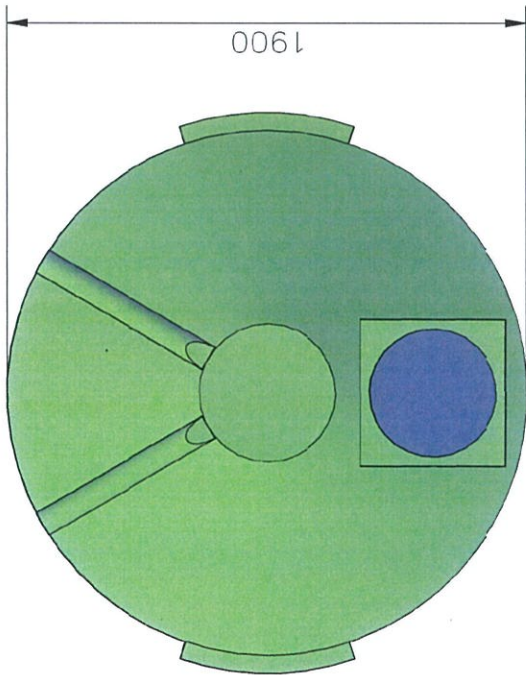

**OZZI KLEEN**  
**COLLECTION WELL**  
**MODEL PT5300**  
**FLAT BASE**  
**5,350 LITRE CAPACITY**



**APPROVED**  
**23 OCT 2018**  
**NSW MINISTRY OF HEALTH**

23/11/15	ISSUED FOR APPROVAL	1	YH	BY
DATE	DESCRIPTION	REV.	YH	BY
Suncoast Waste Water Management				
		59 INDUSTRIAL AVE KUNDA PARK QLD 4556 PH +61 7 5469 4800 FAX +61 7 5469 4677 www.ozzikleen.com		
CLIENT		GENERAL		
PROJECT		COLLECTION WELL PT5300 FLAT BASE		
TITLE		GENERAL DRAWING		
DWG NO.		GD - PT5300FB-H10		
DESIGN	MC	DRAWN	YH	
CHKD	AP	DATE	23/11/15	
SCALE	NTS			

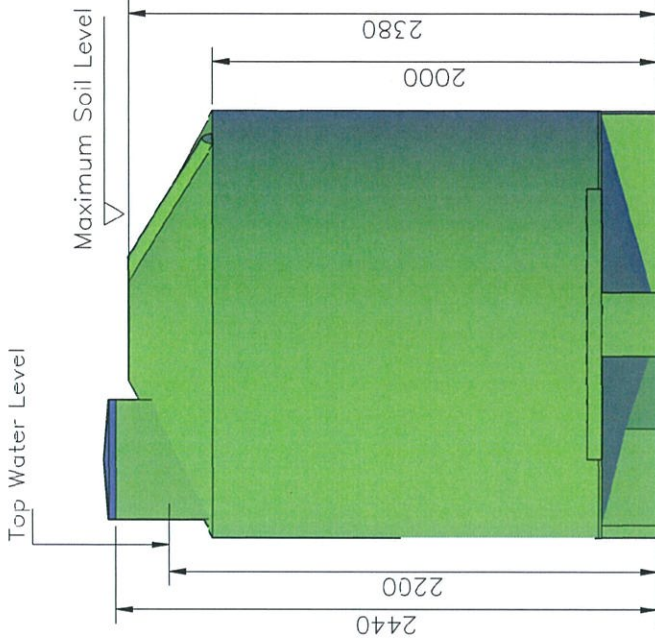
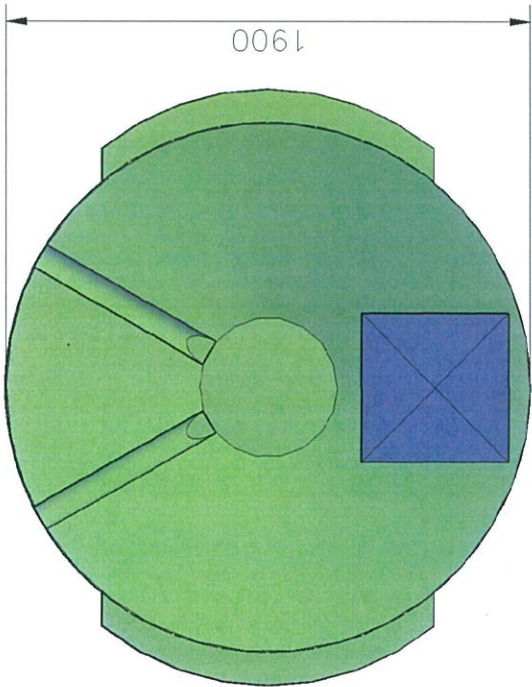

**OZZI KLEEN  
COLLECTION WELL  
MODEL PT5300  
HOPPER BASE  
5,250 LITRE CAPACITY**

**APPROVED**  
**23 OCT 2018**  
**NSW MINISTRY OF HEALTH**

**Certified Product**<sup>TM</sup>  
**Australian Standard**  
AS/NZS 1546.1  
Lic SMK20032  
SAI Global

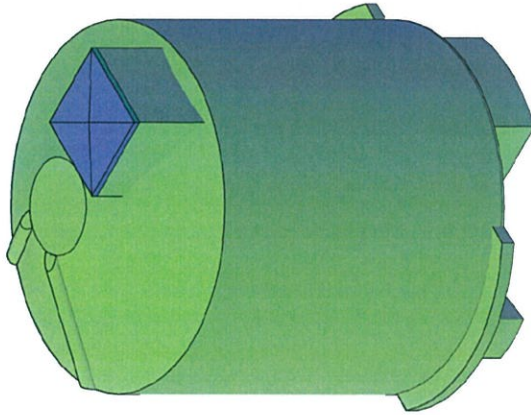

59 INDUSTRIAL AVE KUNDA PARK QLD 4350 AUSTRALIA TEL +61 7 5459 4900 FAX +61 7 5458 4677 www.ozzikleen.com	CLIENT GENERAL	DESIGN MC	
PROJECT COLLECTION WELL PT5300 HOPPER BASE	DRAWN CHKD	YH AP	
TITLE GENERAL DRAWING	DATE 23/11/15	SCALE NTS	
DWG NO. GD-PT5300HB-H10			
 Suncoast Waste Water Management			
23/11/15	ISSUED FOR APPROVAL	1	YH
DATE	DESCRIPTION	REV.	BY

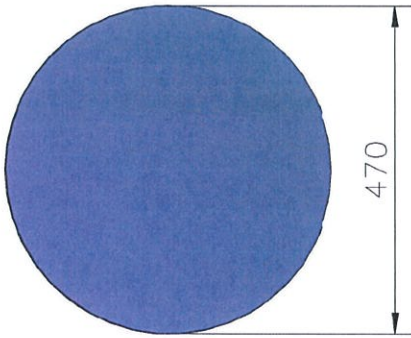

APPROVED  
23 OCT 2018  
NSW MINISTRY OF HEALTH



**Australian Standard**  
AS/NZS 1546.1  
Lic SMK20032  
SAI Global

**OZZI KLEEN  
COLLECTION WELL  
MODEL PT350  
350 LITRE CAPACITY**

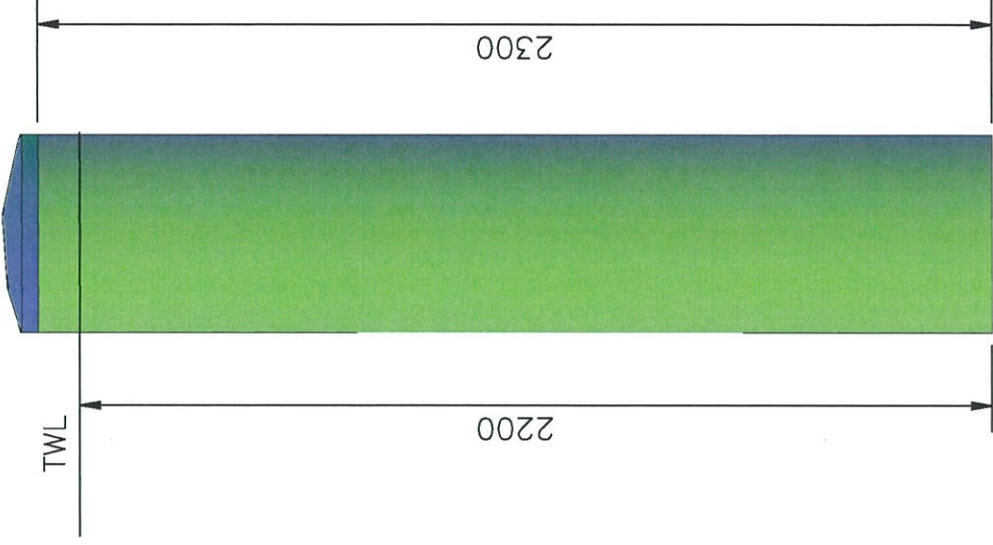
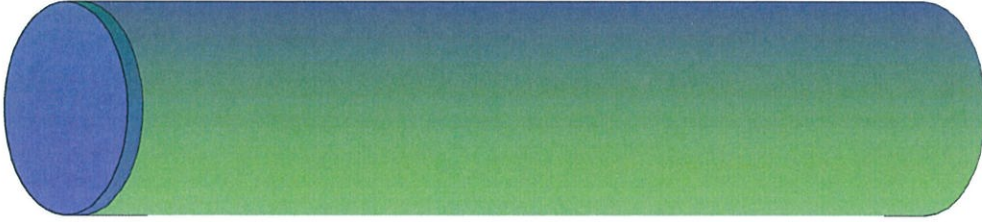

Suncoast Waste Water Management

59 INDUSTRIAL AVE  
KUNDA PARK  
QLD 4356  
TEL +61 7 5458 4000  
FAX +61 7 5458 4677  
www.ozzikleen.com

CLIENT  
GENERAL

PROJECT  
COLLECTION WELL PT350

TITLE  
GENERAL DRAWING

DWG NO. GD-PT350-H10

DESIGN	MC
DRAWN	YH
CHKD	AP
DATE	23/11/15
SCALE	NTS

DATE	ISSUED FOR APPROVAL	DESCRIPTION	REV.	BY	YH
23/11/15	1				

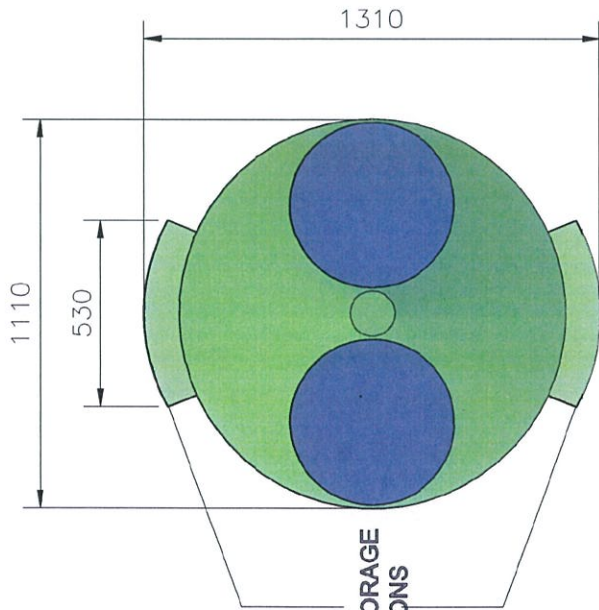

TANK ANCHORAGE EXTENSIONS

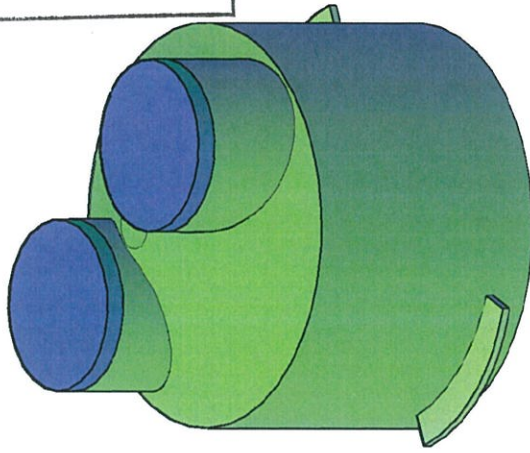
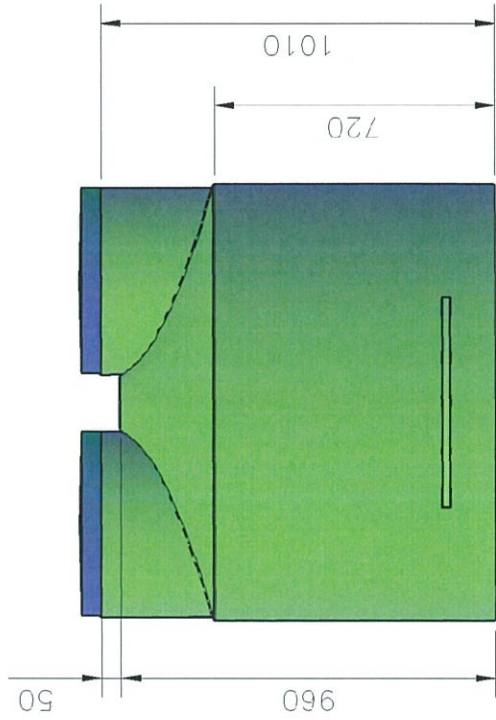

APPROVED  
23 OCT 2018  
NSW MINISTRY OF HEALTH



Australian Standard  
AS/NZS 1546.1  
Lic SMK20032  
SAI Global

**OZZI KLEEN**  
**COLLECTION WELL**  
**MODEL PT500**  
**FLAT BASE**  
**663 LITRE CAPACITY**



58 INDUSTRIAL AVE  
KUNDA PARK  
QLD 4556  
PH +61 7 5458 4900  
FAX +61 7 5458 4877  
www.ozzikleen.com

CLIENT	GENERAL	DESIGN	MC
PROJECT	COLLECTION WELL PT500 FLAT BASE	DRAWN	YH
TITLE	GENERAL DRAWING	CHKD	AP
DWG NO.	GD-PT500FB-H10	DATE	15/04/16
		SCALE	NTS

Suncoast Waste Water Management

DATE	DESCRIPTION	REV.	YH	BY
15/04/16	ISSUED FOR APPROVAL	1	YH	

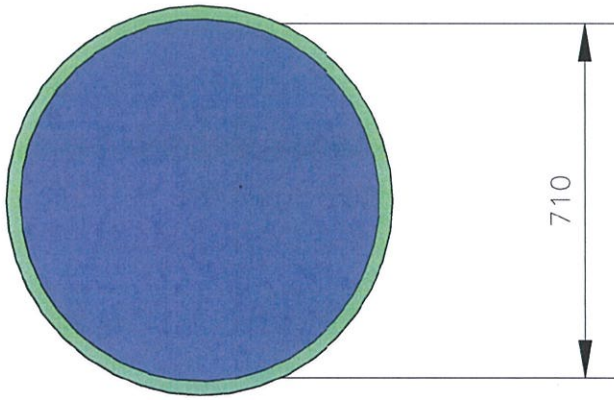

**Australian Standard**  
 AS/NZS 1546.1  
 Lic SMKB20032  
 SAI Global

**OZZI KLEEN  
 COLLECTION WELL  
 MODEL PT850  
 850 LITRE CAPACITY**

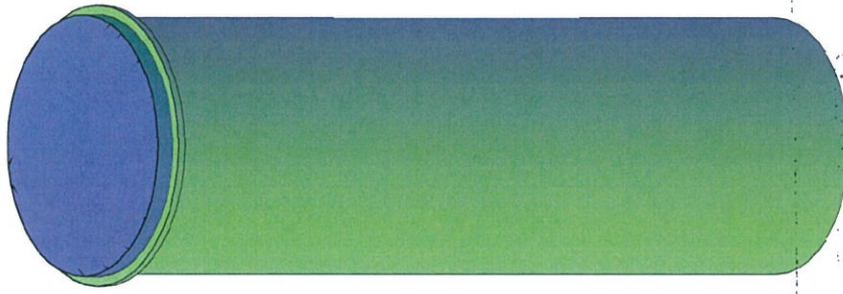

23 OCT 2018

NSW MINISTRY OF HEALTH

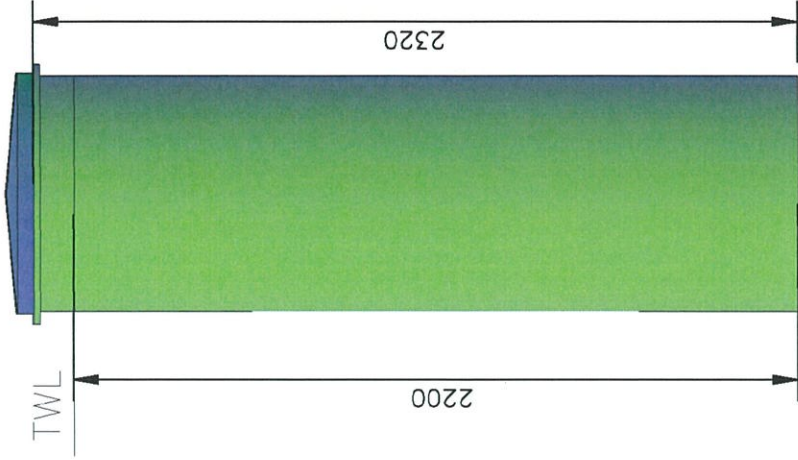

23/11/15	ISSUED FOR APPROVAL	1	YH	BY
DATE	DESCRIPTION	REV.		
Suncoast Waste Water Management				
59 INDUSTRIAL AVE KUNDA PARK NSW 4350 PH +61 7 5459 4900 FAX +61 7 5456 4677 www.ozzicleen.com		CLIENT GENERAL PROJECT COLLECTION WELL PT850 TITLE GENERAL DRAWING DWG NO. GD-PT850-H10		
DESIGN	MC	YH	AP	NTS
DRAWN	CHKD	DATE	SCALE	

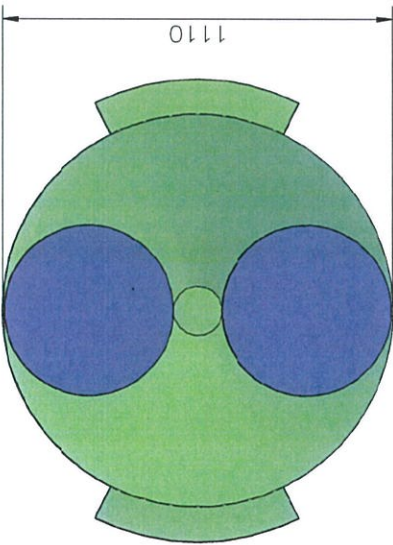

Australian Standard  
AS/NZS 1546.1  
Lic SMKBE20032  
SAI Global

**OZZI KLEEN  
PUMP CHAMBER  
(HOLDING TANK)  
MODEL PT1500  
FLAT BASE  
1735 LITRE CAPACITY**

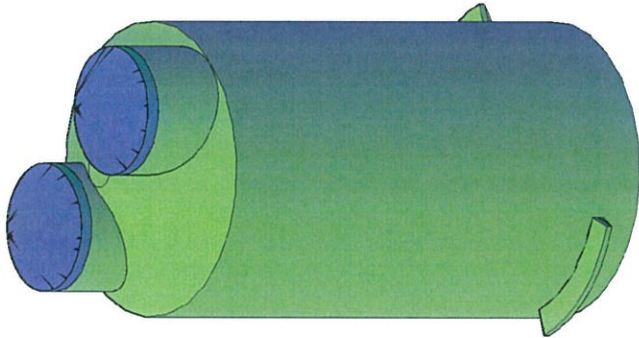

**APPROVED**  
23 OCT 2018  
NSW MINISTRY OF HEALTH

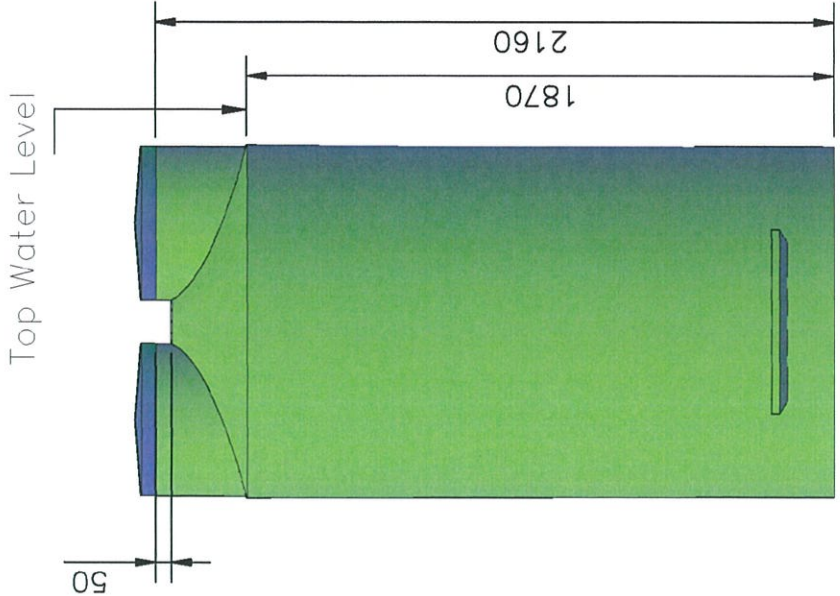

DATE	DESCRIPTION	REV.	YH	BY
23/11/15	ISSUED FOR APPROVAL	1	YH	

59 INDUSTRIAL AVE KUNDA PARK QLD 4656 PH +61 7 5459 4800 FAX +61 7 5458 4877 www.ozzikleen.com		CLIENT GENERAL PROJECT COLLECTION WELL PT1500 FLAT BASE TITLE GENERAL DRAWING DWG NO. GD-PT1500FB-H10	DESIGN MC DRAWN YH CHKD AP DATE 23/11/15 SCALE NTS
		Suncoast Waste Water Management	

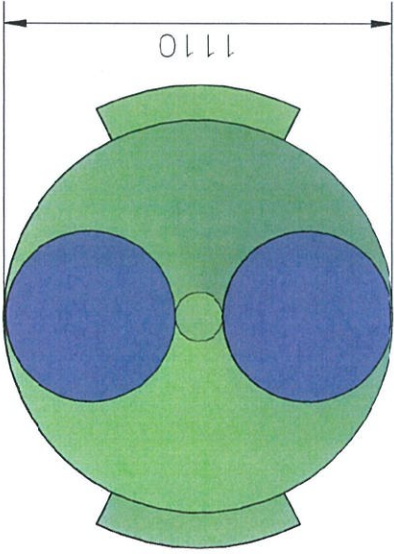

**OZZI KLEEN  
PUMP CHAMBER  
(HOLDING TANK)  
MODEL PT1500  
HOPPER BOTTOM  
1640 LITRE CAPACITY**

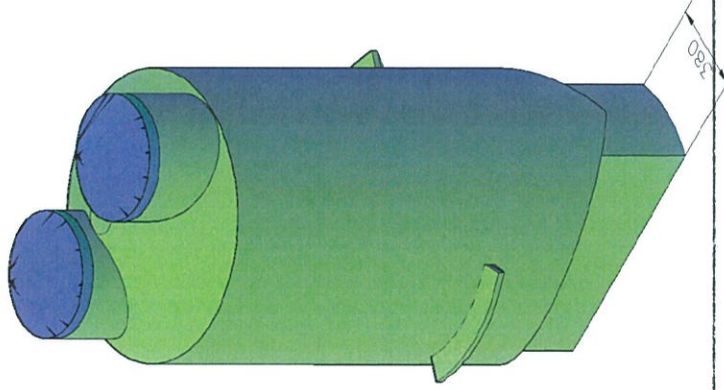

**APPROVED  
23 OCT 2018**

**NSW MINISTRY OF HEALTH**

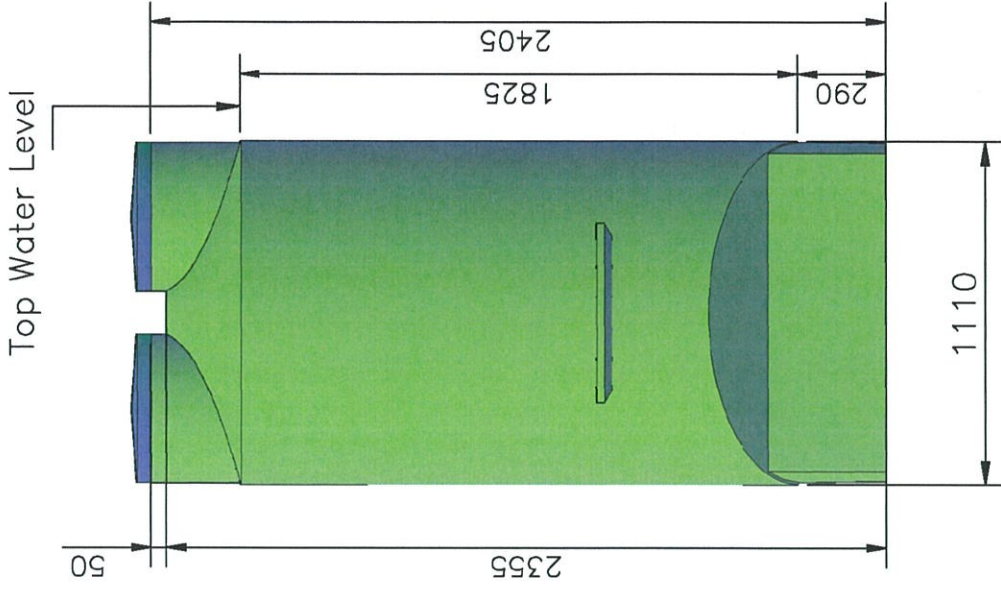

DATE	ISSUED FOR APPROVAL	DESCRIPTION	REV.	BY	YH
23/11/15	1				

56 INDUSTRIAL AVE  
KUNDA PARK  
QLD 4845  
TEL +61 7 5459 4690  
FAX +61 7 5456 4677  
www.ozzikleen.com



Suncoast Waste Water Management

CLIENT	GENERAL	DESIGN	MC
PROJECT	COLLECTION WELL PT1500 HOPPER BOTTOM	DRAWN	YH
TITLE	GENERAL DRAWING	CHKD	AP
DWG NO.	GD-PT1500HB-H10	DATE	23/11/15
		SCALE	MTS